

Features:

- Octave bandwidth, specification from 100~1000MHz
- Low noise figure, high gain with good gain flatness
- Low VSWR, unconditional stable
- Small size, low cost
- SMA female connector I/O
- Single DC power supply
- Operating temperature -40~+75°C, storage temperature -55~+125°C

Electrical Specifications

Parameters	Minimum	Typical	Maximum
Frequency Range	100 MHz		1000MHz
P-1dB Compression Point	+29 dBm	+30 dBm	
Output IP3	+40 dBm	+43 dBm	
Nominal SS Gain @25°C	27 dB	30dB	33 dB
Gain flatness		+/-1.0 dB	+/-1.25 dB
Gain Variation		+/-1.2 dB	
Noise Figure		4.5 dB	5.0 dB
Input VSWR		1.5:1	1.8:1
Output VSWR		1.5:1	1.8:1
Reverse Isolation	40 dB	45dB	
Spurious			-60 dBc
Operating Temperature	-40°C		+75°C
Survival Temperature	-55°C		+125°C
DC Voltage	+11V	+12 V	+13 V
DC Supply Current	325 mA	375 mA	425 mA
In/Out connectors	SMA female		
Size	1.5"x1.0"x0.4"		

Functional Diagram

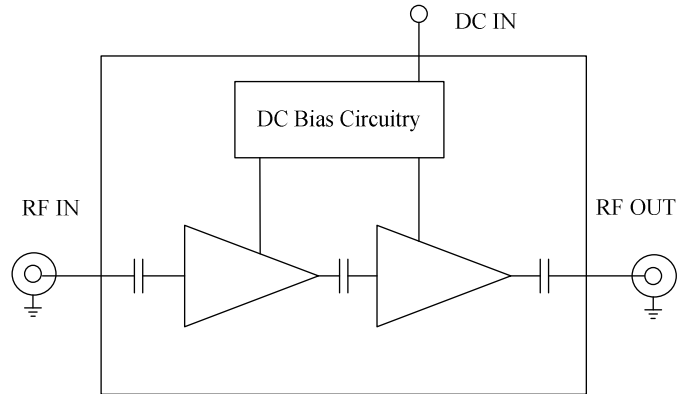

Mechanical Structure:

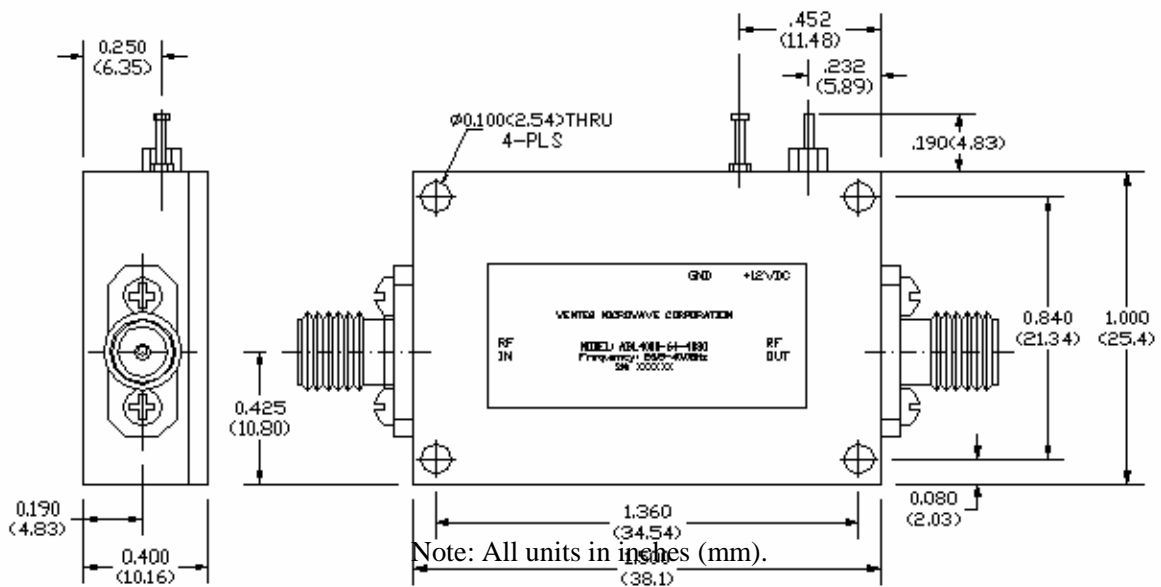

Absolute Maximum Ratings

DC Voltage	+13V
RF Input Power	+10dBm
Storage Temperature	-55~+125°C
Operating Temperature	-40~+75°C